

Specifications:

Axial Sensitivity (20±5°C)	150 pC/g
Measurement Range (Peak Value)	600 g
Transverse Sensitivity	≤ 5%
Frequency Response (±5%)	0.2~4000 Hz
Mounting Resonance Frequency	15 kHz
Operation Temp. Range	-40~+150 °C
Temperature Response	Refer to Temp. Curve
Temperature Coefficient	4 mg/°C(0.3Hz)
Magnetic Sensitivity	2 g/T
Base Strain Sensitivity	0.2 mg/με
Insulation Resistance	≥10 ⁹ Ω
Capacitance	~2000 pF
Mounting Method	M5
Sensing Element	PZT-5
Sensing Geometry	Shear
Case Material	Stainless Steel
Weight	38 g
Output Type	L5 (Top)
Grounding	Signal Ground Connected to Case
M5 stud, Protection Cap	Included
Low Noise Cable L5 to BNC	Included
Calibration Certificate	Included

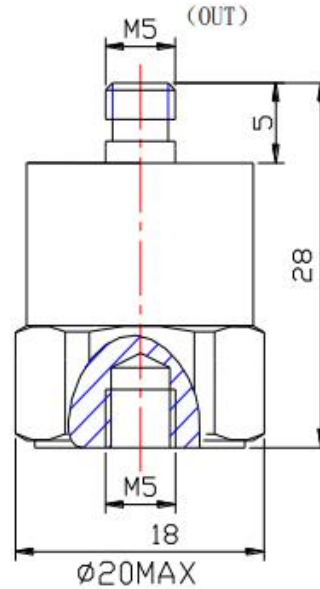

Schematic diagram

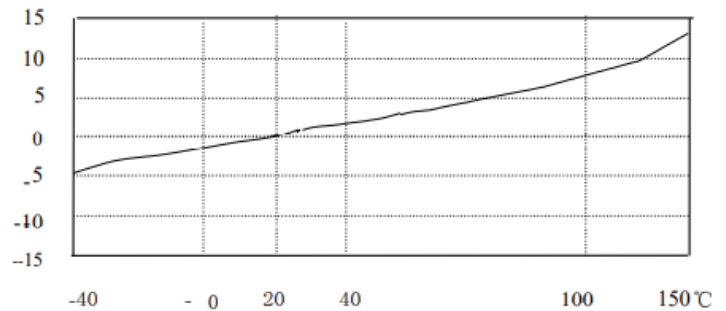

Typical Temperature Response Curve

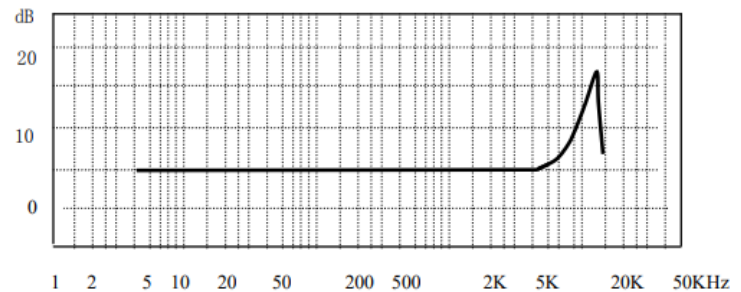

Typical Frequency Response Curve